

Braytron

TECHNISCHES DATENBLATT

MODELL

BY41-10311

BESCHREIBUNG

BRY-SRC12-48VDC-26.6×52.5-BLC-MAG.RAIL

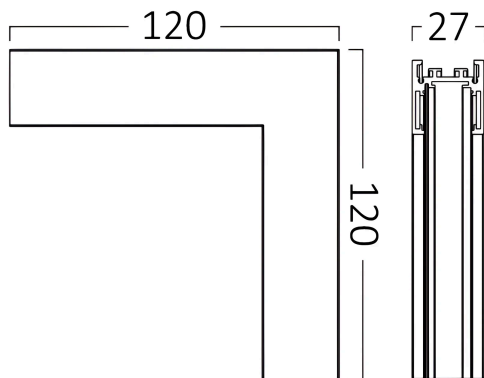
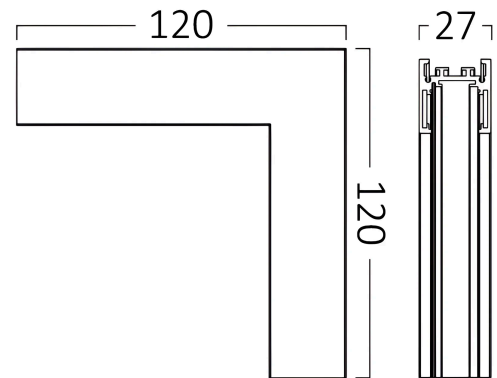

BRAYTRON SRL

MUNICIPIUL BUCUREȘTI, SECTOR 6, BLD. IULIU MANIU, NR.616, CORP B, ET.1,BUCUREȘTI,Sector 6(RO)

info@braytron.com

www.braytron.com

Pagina 1 din 2

Allgemeine Merkmale

Modell	:	BY41-10311
Hauptkategorie	:	Schienenbeleuchtung
Unterkategorie	:	Stromschienen
Typ	:	Mag.Rail
Gehäusefarbe	:	Black
Garantie	:	3 Years
Klasse	:	CLASS III
IP (Schutzart)	:	IP20

Elektrische Eigenschaften

Spannung	:	48VDC
Material	:	Aluminium
Arbeitstemperatur	:	-20°C ~ +40°C

Dimensions & Weight

Länge	:	120 mm
Breite	:	120 mm
Höhe	:	27 mm
Gewicht	:	125 gr

Paket-Informationen

Nettogewicht	:	1,00 kgs
Bruttogewicht	:	1,40 kgs
Stückzahl pro Karton (PCS/CTN)	:	8
Länge	:	270 mm
Breite	:	170 mm
Höhe	:	150 mm
EAN-Code	:	5949097722882