

Braytron

TECHNISCHES DATENBLATT

MODELL

BY42-00130

BESCHREIBUNG

BRY-M20C-TR01-3M-48VDC-WHT-MAG.RAIL

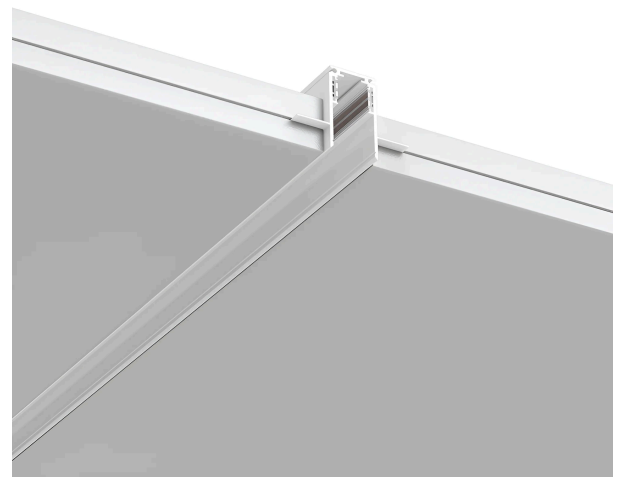
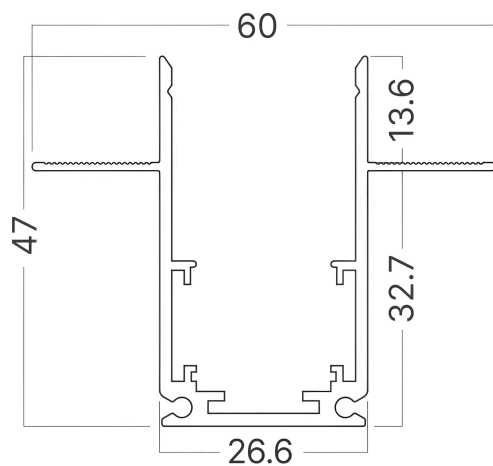
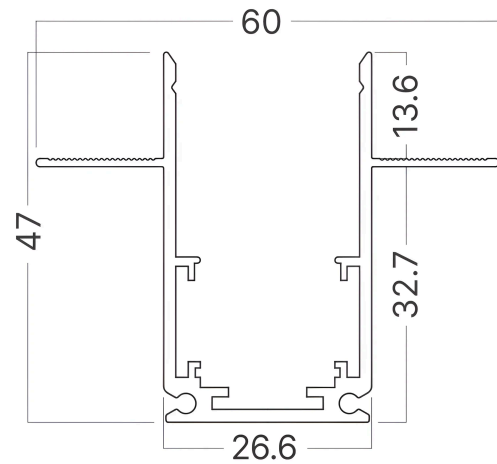
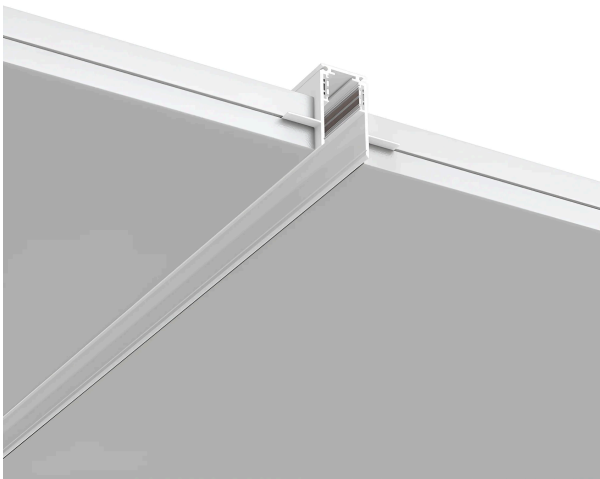

BRAYTRON SRL

MUNICIPIUL BUCUREȘTI, SECTOR 6, BLD. IULIU MANIU, NR.616, CORP B, ET.1,BUCUREȘTI,Sector 6(RO)

info@braytron.com

www.braytron.com

Allgemeine Merkmale

Modell	:	BY42-00130
Hauptkategorie	:	Schienenbeleuchtung
Unterkategorie	:	Stromschienen
Gehäusefarbe	:	White
Garantie	:	3 Years
Klasse	:	CLASS III
IP (Schutzart)	:	IP20

Elektrische Eigenschaften

Lebensdauer	:	30000 h
Spannung	:	48VDC
Material	:	Aluminium
Arbeitstemperatur	:	-20°C ~ +40°C

Dimensions & Weight

Länge	:	3000 mm
Breite	:	60 mm
Höhe	:	60 mm

Paket-Informationen

EAN-Code	:	5949097754234
----------	---	---------------