

Braytron

TECHNISCHES DATENBLATT

MODELL	BY42-00131
BESCHREIBUNG	BRY-M20C-TR01-3M-48VDC-BLC-MAG.RAIL

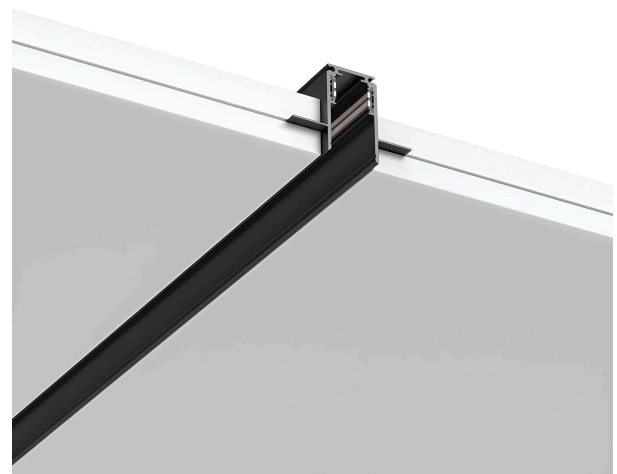
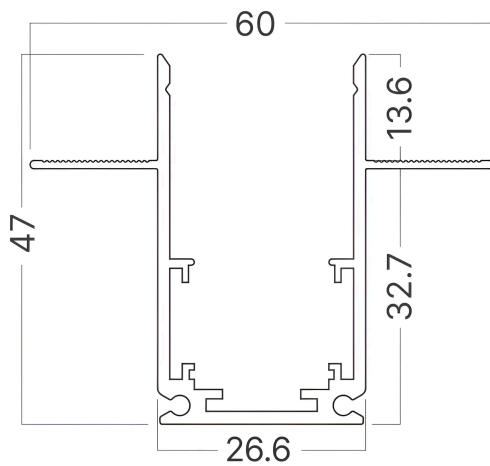
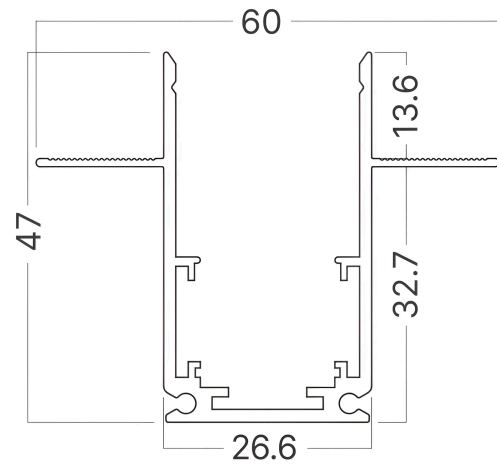
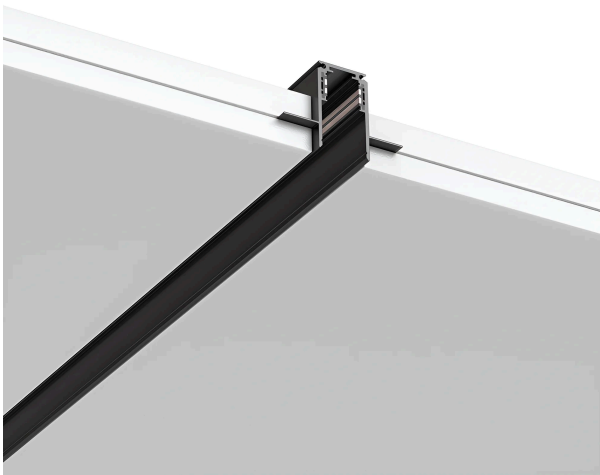

BRAYTRON SRL

MUNICIPIUL BUCUREȘTI, SECTOR 6, BLD. IULIU MANIU, NR.616, CORP B, ET.1,BUCUREȘTI,Sector 6(RO)
info@braytron.com
www.braytron.com

Allgemeine Merkmale

Modell	:	BY42-00131
Hauptkategorie	:	Schienenbeleuchtung
Unterkategorie	:	Stromschienen
Typ	:	Mag.Rail
Gehäusefarbe	:	Black
Garantie	:	3 Years
Klasse	:	CLASS III
IP (Schutzart)	:	IP20

Elektrische Eigenschaften

Lebensdauer	:	30000 h
Spannung	:	48VDC
Material	:	Aluminium
Arbeitstemperatur	:	-20°C ~ +40°C

Dimensions & Weight

Länge	:	3000 mm
Breite	:	60 mm
Höhe	:	60 mm

Paket-Informationen

Stückzahl pro Karton (PCS/CTN)	:	8
EAN-Code	:	5949097744204