

# Braytron

## TECHNISCHES DATENBLATT

MODELL

BY90-01311

BESCHREIBUNG

BRY-17,6x12,9-100pcs/bag-PA66-WHT-CABLE TIES SCREW MOUNT

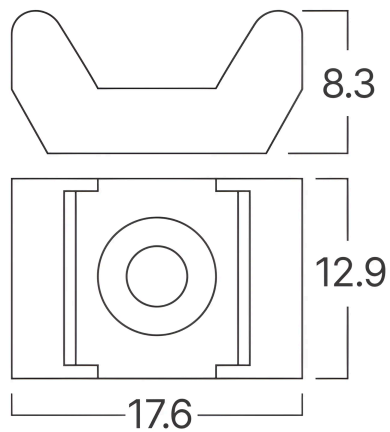
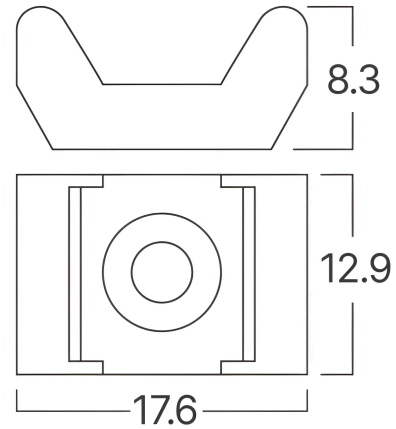

BRAYTRON SRL

MUNICIPIUL BUCUREȘTI, SECTOR 6, BLD. IULIU MANIU, NR.616, CORP B, ET.1,BUCUREȘTI,Sector 6(RO)

info@braytron.com

www.braytron.com

Pagina 1 din 2

## Allgemeine Merkmale

Modell	:	BY90-01311
Hauptkategorie	:	Elektroartikel
Unterkategorie	:	Cable Ties
Typ	:	Screw Mount
Gehäusefarbe	:	White
Garantie	:	2 Years

## Elektrische Eigenschaften

Material	:	PA66
Arbeitstemperatur	:	-40°C ~ +85°C

## Dimensions & Weight

Länge	:	17,6 mm
Breite	:	12,9 mm
Höhe	:	8,3 mm

## Paket-Informationen

Stückzahl pro Karton (PCS/CTN)	:	100
Länge	:	55 cm
Breite	:	40 cm
Höhe	:	21 cm
EAN-Code	:	5949097752995