

Braytron

TECHNISCHES DATENBLATT

MODELL

BY90-01322

BESCHREIBUNG

BRY-21,3x15,3-100pcs/bag-PA66-BLC-CABLE TIES SCREW MOUNT

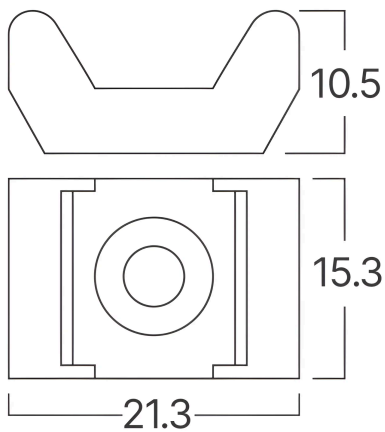
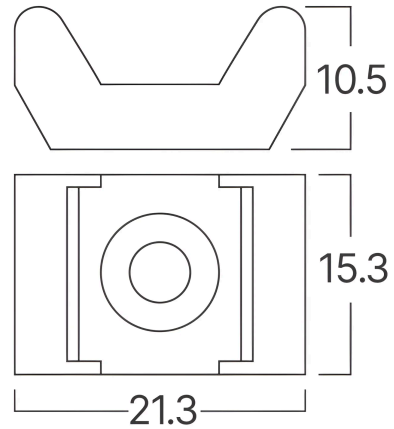

BRAYTRON SRL

MUNICIPIUL BUCUREȘTI, SECTOR 6, BLD. IULIU MANIU, NR.616, CORP B, ET.1,BUCUREȘTI,Sector 6(RO)

info@braytron.com

www.braytron.com

Allgemeine Merkmale

Modell	:	BY90-01322
Hauptkategorie	:	Elektroartikel
Unterkategorie	:	Cable Ties
Typ	:	Screw Mount
Gehäusefarbe	:	Black
Garantie	:	2 Years

Elektrische Eigenschaften

Material	:	PA66
Arbeitstemperatur	:	-40°C ~ +85°C

Dimensions & Weight

Länge	:	21,3 mm
Breite	:	15,3 mm
Höhe	:	8,3 mm

Paket-Informationen

Stückzahl pro Karton (PCS/CTN)	:	50
Länge	:	55 cm
Breite	:	40 cm
Höhe	:	17 cm
EAN-Code	:	5949097753022